



FITMENT INSTRUCTIONS

LT-50 Ladder Storage Bracket Kit

Installation Instructions

Preliminary information

Installation and fitment instructions including tools required, fasteners, kit, and the hardware..

Please follow the instructions and check installation actions with the images in this document.



Service Enquiries email
queries@alu-cab.com

Installation Instructions

The Ladder Mounting Bracket can be used with the ladder in or out of the bag

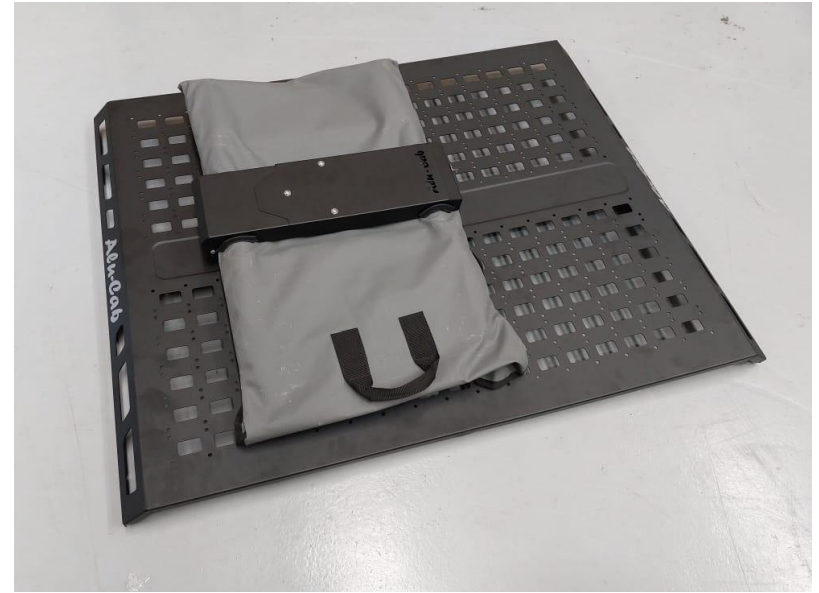
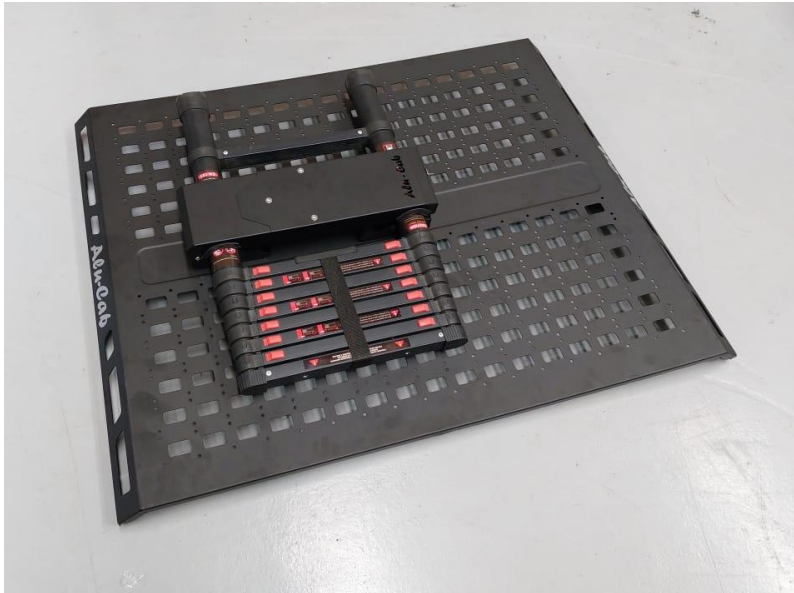

Installation Instructions

Canopy Fitment – Tools, Fasteners & Hardware

1.1

Tools & Items Required

4mm Allen Key
3mm Allen Key
10mm Spanner / Socket
8mm Spanner / Socket

1.3

Hardware Required

Ladder mounting bracket	1
Shims	2

1.2

Fasteners Supplied (included with Side Boxes)

M6x16mm Button heads	6
M6 Nyloc Nut	6
M6 Flat Washer	12
M5x10mm Button heads	8
M5 Nyloc Nut	8
M5 Flat Washer	8
M5 Plastic nut caps	8

Installation Instructions

2

Shimming the Ladder Mounting Bracket for a smaller / light-weight ladder:

The Ladder Mounting Bracket comes assembled for a standard ladder and shimming brackets need to be fitted for the smaller ladder.

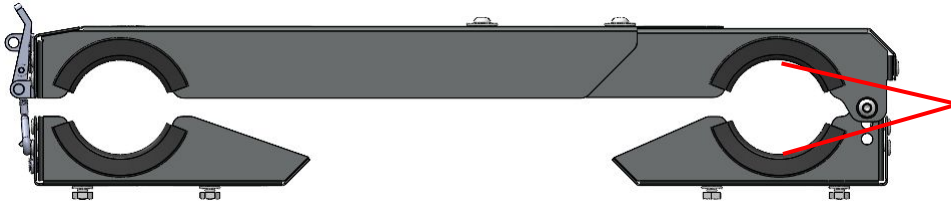

Cradle size for
Large ladder

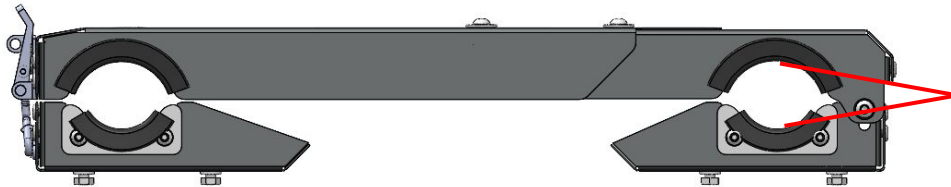

Cradle size for
**Small / light
weight** ladder



Ladder mounting -
bracket shim

Installation Instructions

3 Fitting the shim for smaller / light-weight ladder

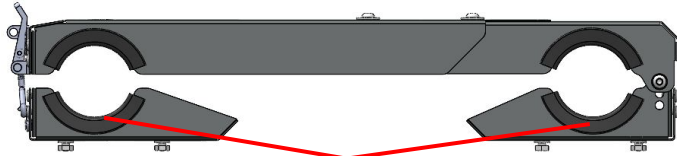

Rubber strip

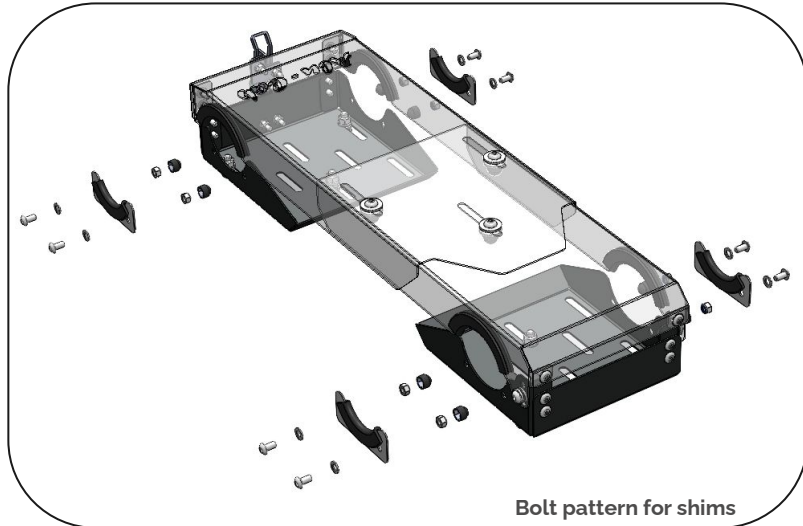

Bolt pattern for shims

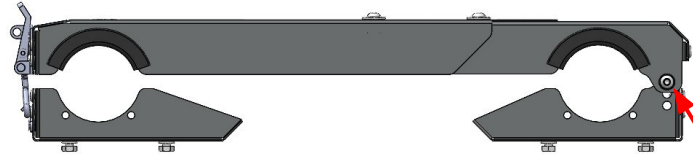

2.1

Remove the rubber strips off the base section of the ladder mounting bracket

2.2

Unfasten the hinge bolts and refasten it in a lower hole setting.

Hinge bolt

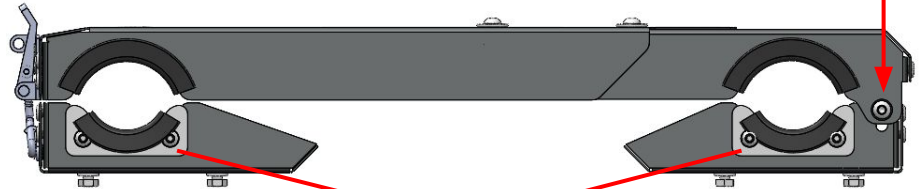

2.3

Bolt the shims onto the base section of the ladder mounting bracket using the M5 Button heads, washers and M5 Nyloc nuts. Place the plastic nut caps over the nuts after tightening.

Installation Instructions

4

Mounting the Ladder Bracket to the Molle Plate:

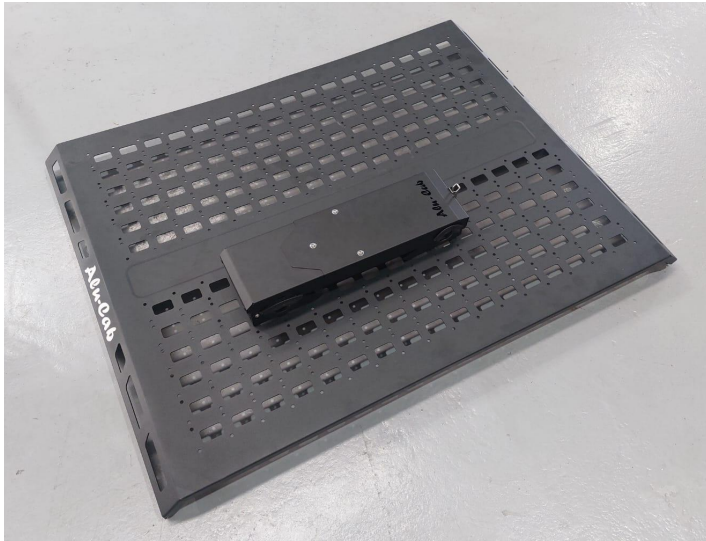

Position the bracket on the Molle Plate where you would like to mount it.

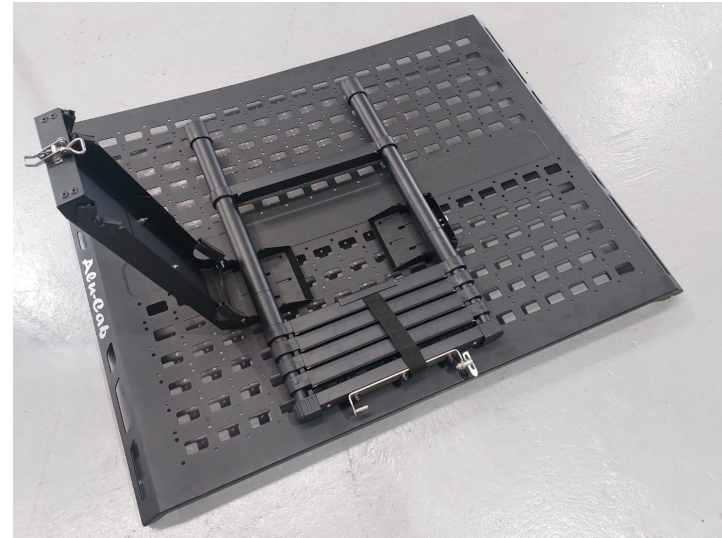

Place the ladder in the bracket to get the spacing distance of the base pieces.

Installation Instructions

5

Mounting the Ladder Bracket to the Molle Plate:

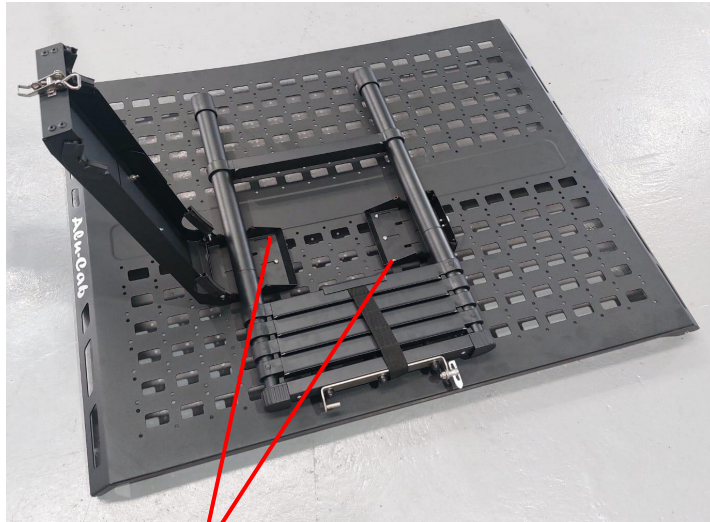

Place the M6 button head bolts and washers through the base pieces and Molle Plate. Fasten the nylock nuts to the bolts holding the bracket base firmly to the Molle Plate.

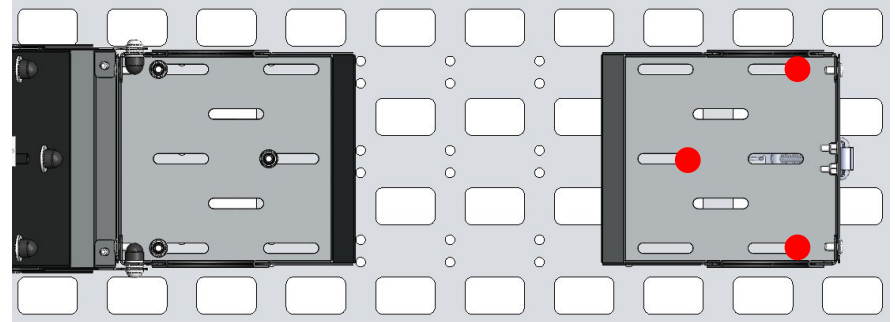

Place the M6 button head bolts in a triangular arrangement for maximum strength.

Installation Instructions

6

Adjusting the top section of the Ladder Mounting Bracket:

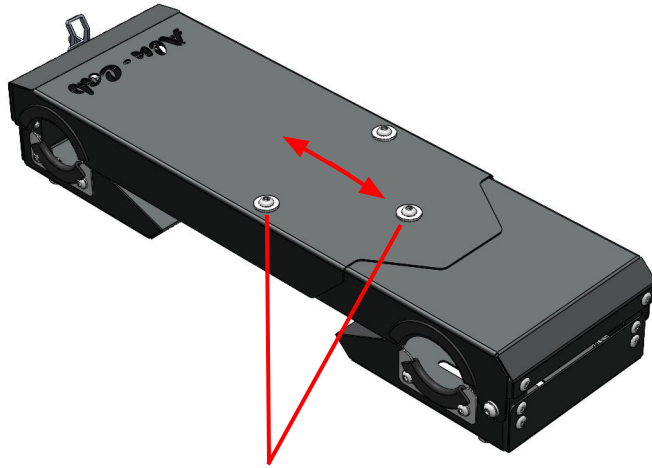

Loosen the top bolts slightly and slide the top section of the ladder bracket to fit the ladder. Tighten the bolts back up after adjustment.

NOTE: Adjust the latch by screwing the loop in or out to ensure that the bracket is under tension while holding the Ladder.

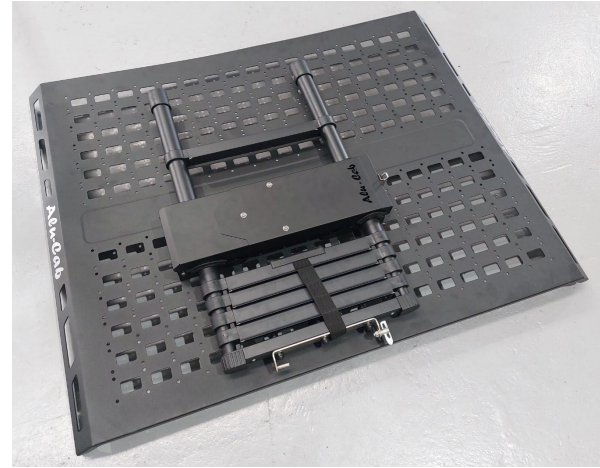

The Ladder Mounting Bracket is now fitted. Ensure to latch the bracket is closed to clamp the bracket securely.



Disclaimer

All rights reserved. No part of this website may be reproduced, translated, stored in a retrieval system, or transmitted, in any form or by any means, electronic, mechanical, photocopying, recording or otherwise, without prior written permission of the owner.

Review all instructions information carefully before installation.

Any damages, direct or incidental to the installer and/or property due to incorrect installation of any parts are the responsibility of the installer. Due to the various applications and fitment options available, the responsibility lies with the user to ensure all mounting points are secure and tight before every trip.

If unsure, consult with your Distributor regarding the operations of our products.

Users are advised to be mindful of the load they are carrying and drive in accordance with road conditions.

WARNING

Always wear appropriate PPE (Personal protection equipment) when fitting our products. Although the mounting kit is designed to be DIY, if you have any doubts or concerns, contact an accredited fitment centre to carry out the work. Alu-Cab will not be liable for any injury to persons, and/or damage to products and/or vehicles.

While Alu-Cab Holdings takes reasonable measures to ensure that the contents of this Website are accurate and complete, Alu-Cab Holdings makes no representations or warranties, whether express or implied, as to the quality, timeliness, operation, integrity, availability or functionality of this Website or as to the accuracy, completeness or reliability of any information on this Website. Alu-Cab Holdings reserves the right to make changes, corrections and/or improvements to the information and to the products and programs described in such information, at any time without notice.

Alu-Cab Holdings will use reasonable endeavours to maintain the availability of the Website, except during scheduled maintenance periods, and reserves the right to discontinue providing the Website or the service or any part thereof with or without notice to you. Any person who accesses this Website or relies on this Website or on the information contained in this Website does so at his or her own risk.

Occasionally, at our discretion, we may include or offer third-party products or services on our website. These third-party sites have separate and independent privacy policies. We therefore have no responsibility or liability for the content and activities of these linked sites. Nonetheless, we seek to protect the integrity of our site and welcome any feedback about these sites.