

READ ME ! 

Thank you for purchasing a Front Runner Pick-Up Roll Top Leg Mount.

Before you start, take a moment to familiarize yourself with the Fitting Instructions and the components received.

Refer to Page 2 for a list of all the components, quantities and tools required.

IMPORTANT WARNING! 

IT IS CRITICAL THAT ALL FRONT RUNNER PRODUCTS BE PROPERLY AND SECURELY ASSEMBLED AND ATTACHED TO YOUR VEHICLE. IMPROPER ATTACHMENT COULD RESULT IN AN AUTOMOBILE ACCIDENT, AND COULD CAUSE SERIOUS BODILY INJURY OR DEATH. YOU ARE RESPONSIBLE FOR ASSEMBLING AND SECURING ALL FRONT RUNNER PRODUCTS TO YOUR VEHICLE, CHECKING THE ATTACHMENTS PRIOR TO USE, AND PERIODICALLY INSPECTING THE PRODUCTS FOR ADJUSTMENT, WEAR AND DAMAGE. THEREFORE, YOU MUST READ AND UNDERSTAND ALL OF THE INSTRUCTIONS AND PRECAUTIONS SUPPLIED WITH YOUR FRONT RUNNER PRODUCT PRIOR TO INSTALLATION OR USE. IF YOU DO NOT UNDERSTAND ALL OF THE INSTRUCTIONS AND CAUTIONS, OR IF YOU HAVE NO MECHANICAL EXPERIENCE AND ARE NOT THOROUGHLY FAMILIAR WITH THE INSTALLATION PROCEDURES, YOU SHOULD HAVE THE PRODUCT INSTALLED BY A PROFESSIONAL INSTALLER OR OTHER QUALIFIED PERSONNEL.

NOTE: Front Runner will not be responsible for any damage caused by the failure to install the product according to these instructions.

Please call us if you have any questions about the installation of this product.

1

GET ORGANIZED

IN THE BOX

1	4 X	M8 x 20 T-Bolt - 18mm Wide
2	2 X	Cover Plates
3	2 X	Leg Mount
4	4 X	M8 x 25 Button Head
5	4 X	M8 x 19 x 2SS Flat Washer
6	8 X	M8 Nut Cap
7	12 X	M8 Nyloc Nut
8	2 X	Leg
9	4 X	M8 x 25 Hex Bolt
10	4 X	M8 x 20 T-Bolt - 14mm Wide

TOOLS NEEDED



FIGURE 1.1

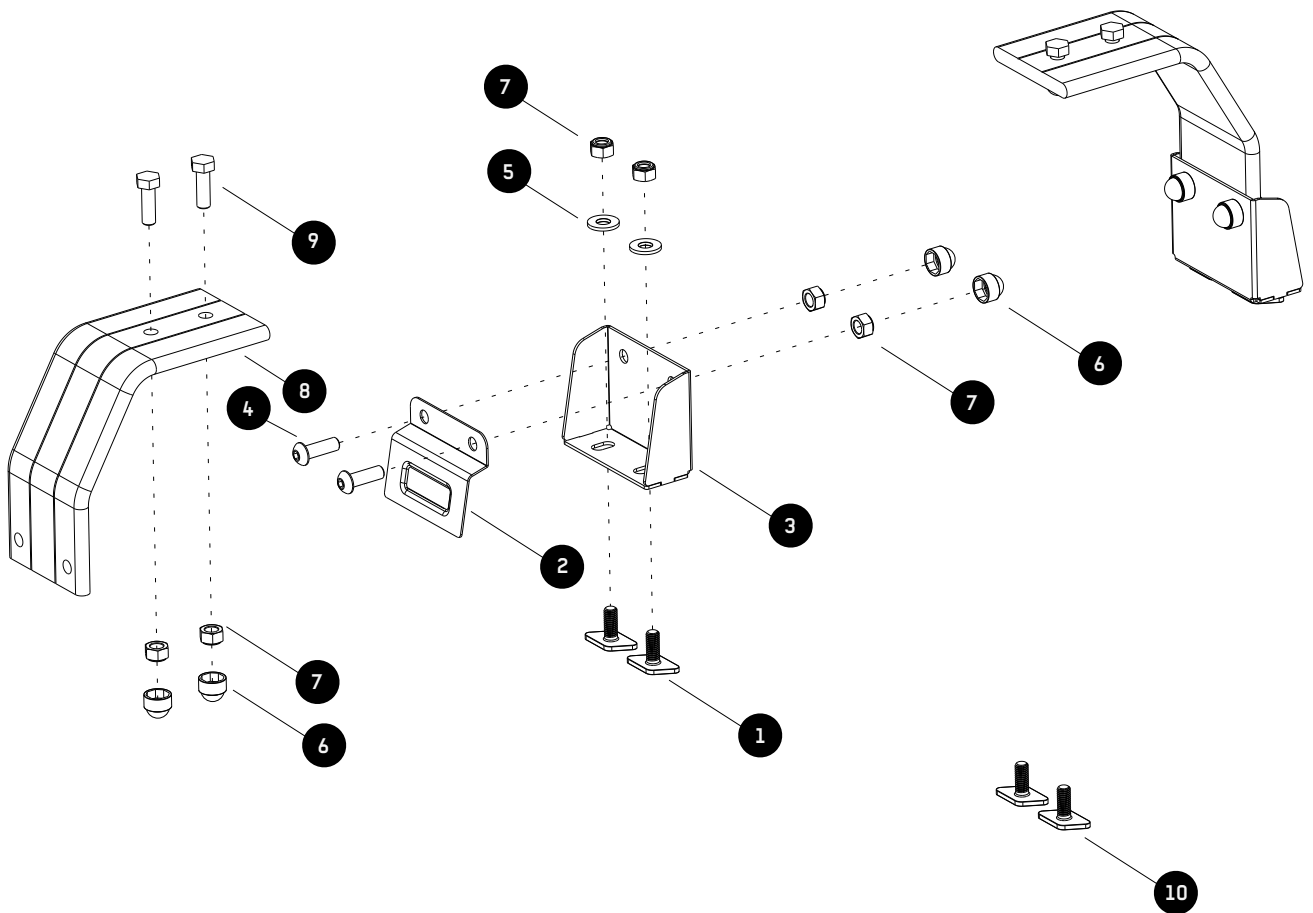

2

FIT AND SECURE

2.1

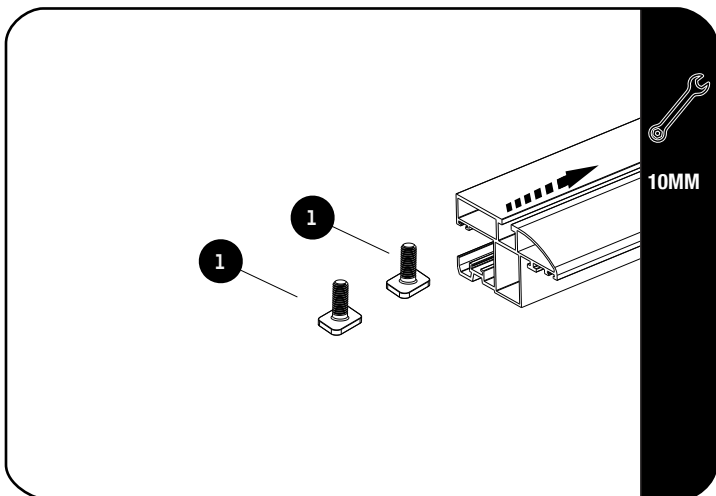

Slide four M8 x 20 T-Bolts (Item 1) into each side profile.

(Four are needed per side to fit Load Bars or a Rack).



Depending on your side profile you might need the 14mm T-Bolt (Item 10).

2.2

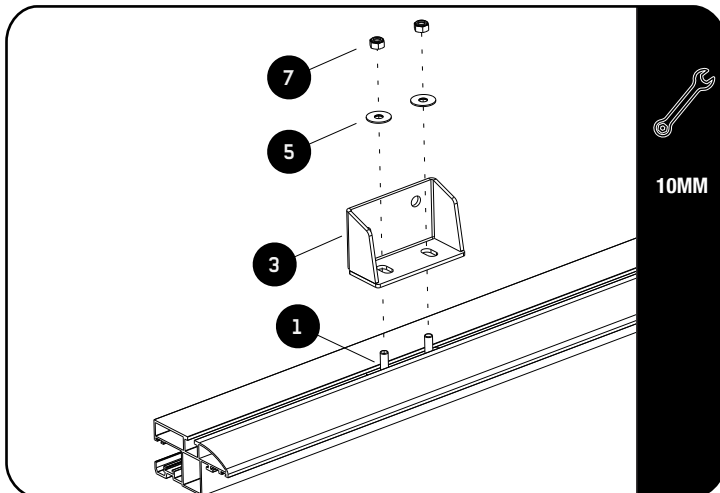

Loosely fit a Leg Mount (Item 3) to each of T-Bolts using M8 x 19 x 2 Flat Washers and M8 Nyloc Nuts (Items 5 & 7).

2.3

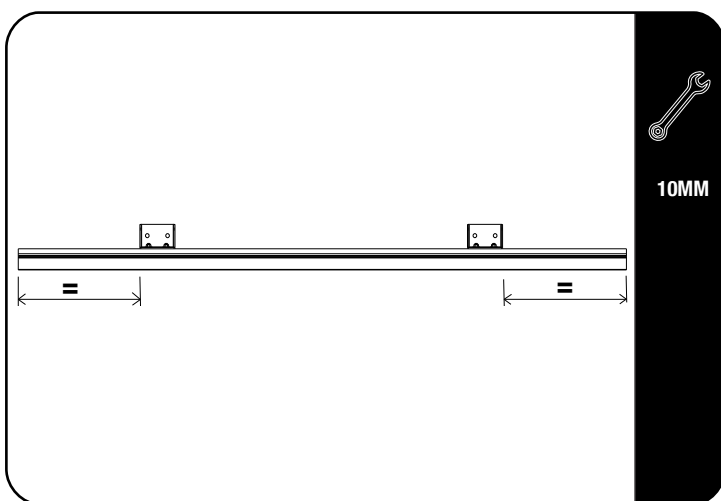

Looking from the side of the vehicle, position the Leg Mounts (Item 3) to center the Slimline II Rack or place Load Bars where desired over the load bed.

2 FIT AND SECURE

2.4

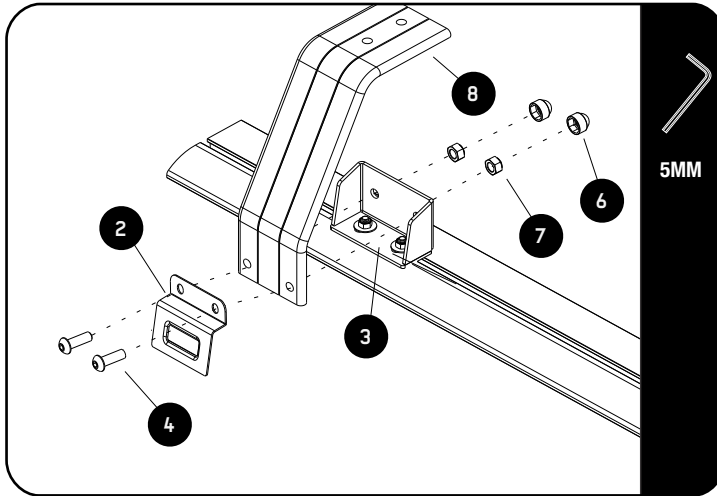

Assemble the Legs (Item 8) to the Leg Mount (Item 3) by using M8 x 30 Button Heads and M8 nyloc Nuts (Items 4 & 7) and the M8 x 20 T-Bolts (Items 1).

2.5

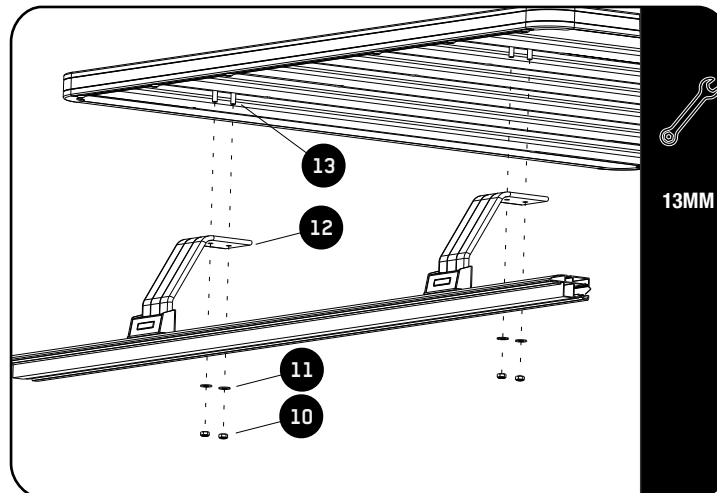

Loosely fit your Slimline II Rack by using M8 x 25 Hex Bolts, M8 x 16 x 1.6SS Flat Washers and M8 Nylocs (Items 10, 11, 13) as shown.

You can use the same method for Load Bars.

2.6

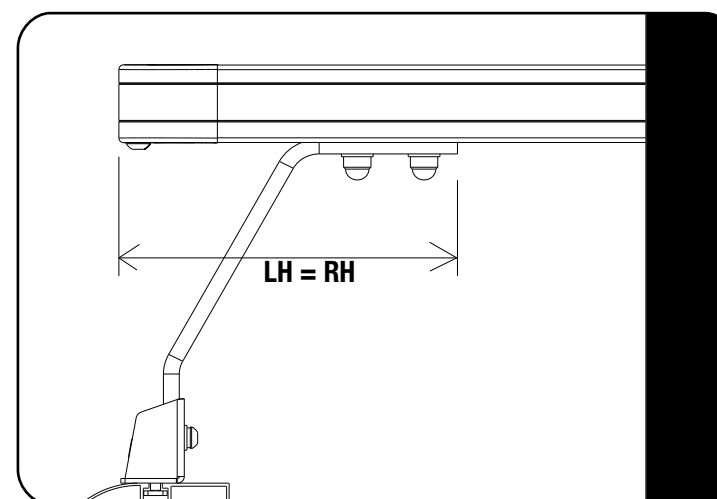

Center the rack on the Legs before fully tightening (LH = RH).

Finish off by placing M8 Nut Caps (Item 9) over all M8 Nyloc Nuts.

Use the same method for Load Bars.

3

FINISH

Congratulations! You did it. Take a step back and admire your work!

4

INSTALL OTHER VEHICLE AND RACK ACCESSORIES

Now's the time to visit your favorite Front Runner Dealer in person or online.

Be sure to tag us. We love to see our gear in action! #FrontRunnerOutfitters #BornToRoam

Share your adventures on: 